

H400 User Manual





Congratulations on your new Hegel H400.

Hegel has been making award-winning audio products for more than 25 years. We are proud of our legacy of creating great-sounding amplifiers. We believe a significant part of our success is that all Hegel products are developed from the ground up by our team in Oslo, Norway. This allows us to use cost-efficient components without compromising on quality and performance and to integrate advanced technologies exclusive to Hegel.

All Hegel products are based on a simple philosophy: Add as little as possible. We work to keep the music signal as close to the original as possible. We are always looking for ways to lower distortion and noise so that the music is only limited by the quality of the recording.

With H400, we have created an amplifier that is truly a testament to our goal of making high-quality products that offer great value for money. Because H400 is not just a really good analog amplifier. It also features a top-tier DAC and a very capable built-in streaming section. With 250 watts of power, a damping factor of 4000, and loads of details and dynamics, this all-in-one music machine will make you want to stomp your feet. So, hook it up to a pair of good speakers and enjoy.

A handwritten signature in black ink, consisting of stylized, overlapping letters that appear to read 'Bent Holter'. The signature is written on a white background.

Bent Holter
Founder Hegel Music System

Index

A word from Bent	2
What's in the box	4
Quickstart	5
General Use	8
Connections	9
Digital Inputs and Formats	10
Network Setup	11
Streaming and Control App	12
Device Menu	14
Remote Control	16
General Information	17
Safety Instructions	18
Warranty and Disclaimers	19

IMPORTANT:

[Before powering on the amplifier, make sure you have read and understood the safety instructions and warnings on page 18!](#)

What's in the box

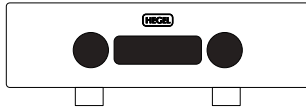

Amplifier

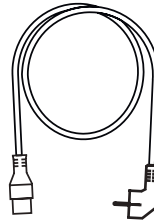

Power Cord



Accessory Box



Remote Control

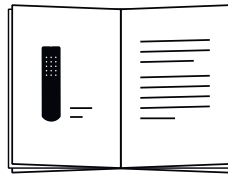

User Manual

Quickstart

1. Connect your speakers

For the best audio experience, the distance between the listener and each speaker should be the same.

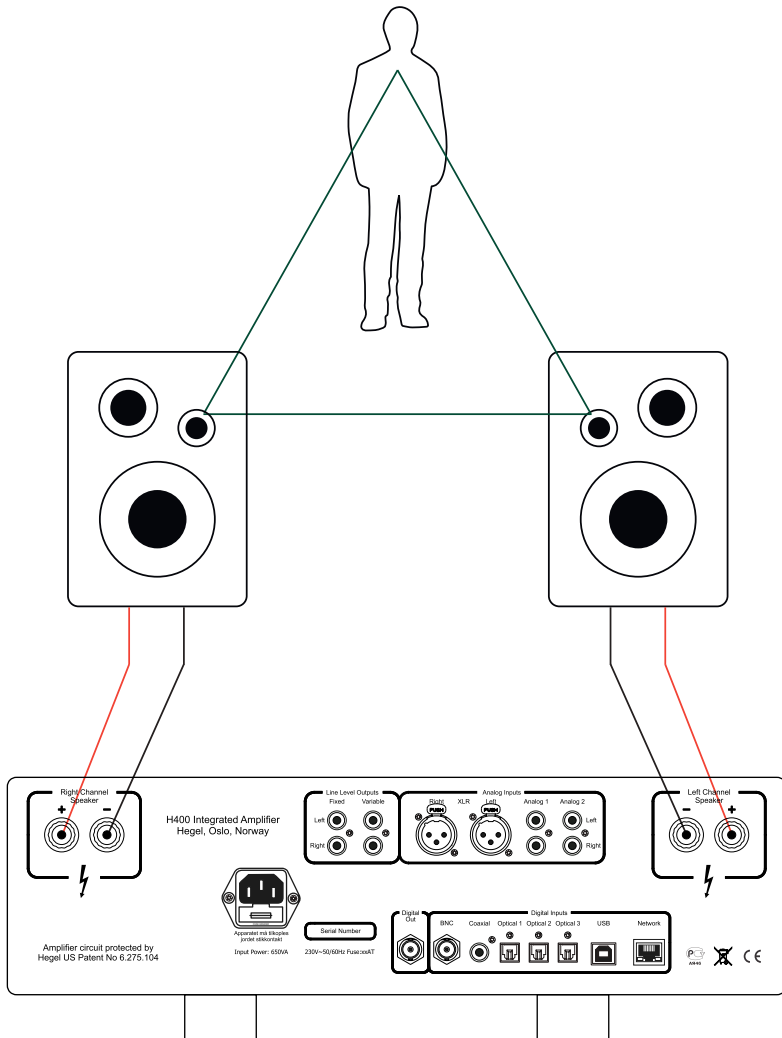

2. Connect a source



Unbalanced Analog

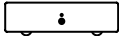
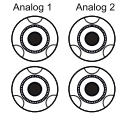

Balanced Analog

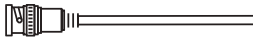
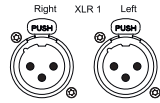

BNC Digital



Coaxial Digital

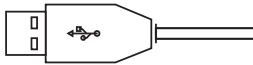

USB Computer

USB

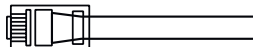

Network Streaming

Network

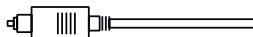

Optical Digital

Optical 1 Optical 2 Optical 3

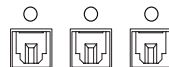

3. Connect the power cord

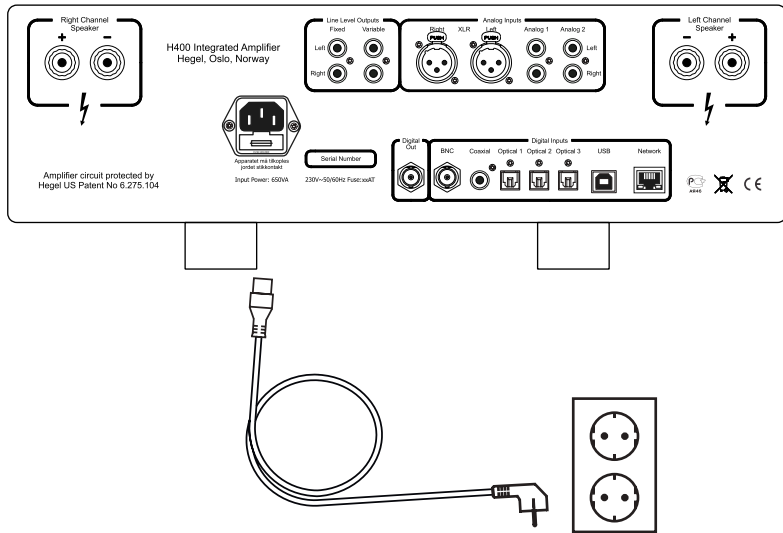

4. Power up the amplifier

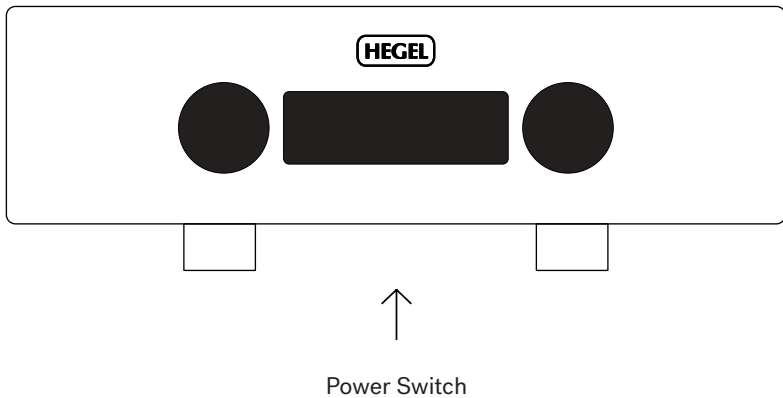

General Use

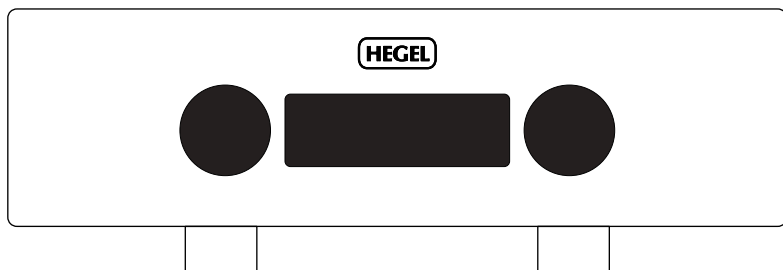

Source Selector

The source can be changed by turning the source selector on the front panel. Press to pause/play. Press and hold to enter the menu. Turn the wheel to navigate. Press to select or enter submenus.

Volume Selector

The volume can be changed by turning the volume selector on the front panel. Press the volume selector to toggle mute on/off. Press to exit the menu.

Power Button

The H400 amplifier can be switched on and off with the power button located on the underside of the amplifier, towards the front of the unit. When powered on, press and hold the power button to reboot the amplifier.

NOTE: When powering up, the H400 takes a few seconds to calibrate, the outputs are muted and the volume flashes to indicate that mute is on. This is normal and is part of the start-up procedure. When the H400 has been switched off, wait 30 seconds before powering it on again.

Sleep/Auto standby

In compliance with the EU Energy Efficiency Directive, the Hegel device will automatically go into standby mode after 15 minutes without sensing a signal, or with a very low signal on the speaker outputs. You can disable or change the Sleep/ Auto Standby settings in the [Device Menu](#). When in standby, a small light in the bottom left corner of the display is lit.

Wake on LAN

By default, the amplifier will not automatically wake when receiving an ethernet (LAN) signal. You can activate this feature in the Auto In settings in the Device Menu.

Automatic Update

When entering standby mode, the device will automatically look for and install new updates. With Wake on LAN enabled, updates will download and install while in standby.

Critical Updates

In rare cases, a critical update may occur. These will download and install immediately, even if the device is in use.

Connections

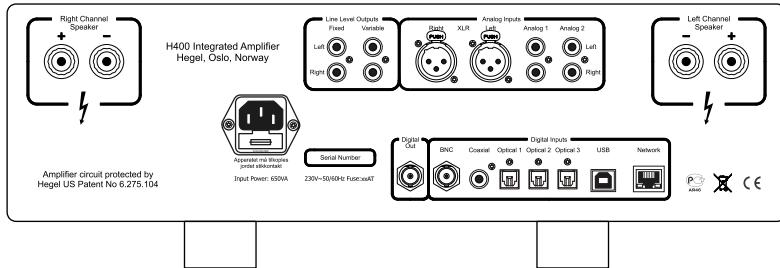

Always power the amplifier off before connecting input/output audio cables and the power cable.

Right Channel Speaker

- Right outputs

Digital Out (DAC loop)

- BNC: Output BNC

Digital Input

- BNC: Input BNC
- Coaxial: Input Coaxial/RCA
- Optical1: Input TOSLINK/EIAJ Optical
- Optical2: Input TOSLINK/EIAJ Optical
- Optical3: Input TOSLINK/EIAJ Optical
- Computer USB input
- Home network connection (LAN - RJ45)

Left Channel Speakers

- Left outputs

Analog Inputs

- XLR: Standard balanced analog input (Pin 1 is Chassis Ground; Pin 2 is Positive Phase; Pin 3 is Negative Phase)
- Analog 1 (RCA): Standard analog input
- Analog 2 (RCA): Standard analog input

Line Level Outputs

- Fixed Line level (RCA)
WARNING High level output
- Variable Line Level (RCA)

AC Power Connection

- AC Power connector with fuse holder:
230V/115V/100V AC depending on country.

Home Theater

Most inputs on the H400 can be used as a Home Theater input, see [Device Menu](#).

Digital Inputs and Formats

Input sense

All digital inputs except USB have input sense. When the H400 detects a signal on one of these inputs it will turn on and switch to the active input.

Please visit support.hegel.com for a detailed description.



Bit perfect DAC

The DAC in the H400 is bit-perfect, meaning it will not alter the resolution or content of an incoming digital signal.

Maximum supported resolution

Coax/BNC:	24/192 + DSD64(DoP)
Optical:	24/96
USB:	32/384 + DSD256(DoP)
Network:	24/192 + DSD64(DoP)

Supported formats UPnP

MP3, WAV, FLAC, ALAC, AAC, PCM, MQA, Ogg

USB

The Hegel H400 has a plug-and-play USB DAC that is designed to work with computers. Connect it to your PC or Mac and enjoy all your music.

MQA (Master Quality Authenticated)

Hegel H400 includes MQA technology, which enables you to play back MQA audio files and streams, delivering the sound of the original master recording.

“MQA” or “MQA.” in the display indicates that the product is decoding and playing an MQA stream or file, and denotes provenance to ensure that the sound is identical to that of the source material. “MQA.” indicates it is playing an MQA Studio file, which has either been approved in the studio by the artist/producer or has been verified by the copyright owner. “OFS” confirms that the product is receiving a decoded MQA stream or file. This delivers the final unfold of the MQA file and displays the original sample rate.

Hegel H400 supports up to MQA 8X (352.8kHz/384kHz)

Visit mqa.co.uk for more information.



Network Setup

Connection

To be able to use the amplifier's network and streaming features, the amplifier needs to be connected to your local network. Connect your Hegel amplifier using an Ethernet cable (not supplied) from the network connection (LAN - RJ45) port on the back of the amplifier to your router.

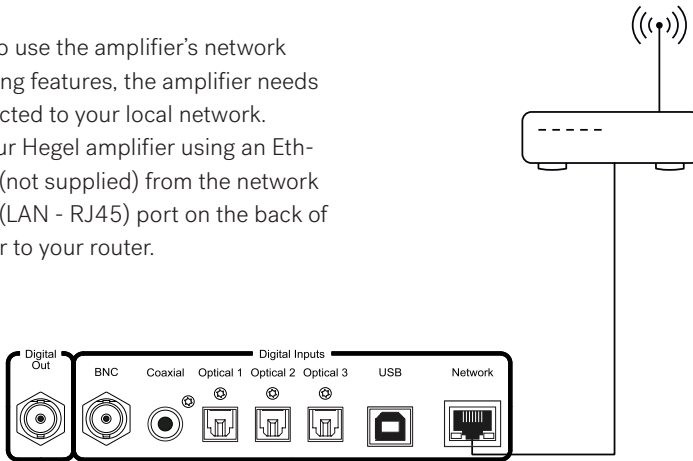

First time setup

To enable all the network features on this device, you need to download and install the Hegel Control app. This can be found on Apple App Store and Google Play. Once installed, please follow the instructions in the app.

For detailed information on the Hegel Control App, supported formats, and much more, please visit support.hegel.com.



NOTE: Some of the features of the Hegel device require an internet connection.

Status Indicators

The Hegel device will display the network status in the lower left corner of the display.

Network status is OK:



Troubleshooting

If you experience problems with connecting the amplifier to the network or have other network issues, when powered on, press and hold the device power button until the device reboots. If that does not help, disconnect the power chord for at least 30 seconds and then reconnect.

Streaming and Control App

AirPlay

With Apple AirPlay, you can enjoy your favorite music or podcasts on your Hegel device.

Choose the Hegel device in the list of AirPlay speakers. Go to apple.com/airplay to learn how.



Spotify Connect

Spotify is all the music you'll ever need. Millions of songs available instantly. Just search for the music you love, or let Spotify play you something great.

Spotify works on your phone, tablet, computer and home-speakers. So you'll always have the perfect soundtrack for whatever you're doing.

Go to connect.spotify.com to learn how to play to your Hegel device.



Tidal Connect

Tidal is a digital music and video streaming service that offers high resolution audio. With Tidal Connect you can stream your favorite music seamlessly across supported devices, without any loss in quality.



Google Cast™

Google Cast is a feature that lets you stream your favorite music from your phone, tablet or laptop right to your amplifier. Simply tap the Cast icon from apps you already know and love to start streaming.

NOTE: To enable Google Cast, it is necessary to accept the Google Terms of Service and Privacy Policy. This is done in the Hegel Control app that can be found in Apple App Store and Google Play.



WARNING:

When streaming to the Hegel device, always remember to check the player/device volume setting before pressing play. The Hegel device will change its volume to the volume set in the player.

Airable

The Airable service enables hiFi systems to meet the changing and challenging online media expectations of consumers. Airable gives access to the market-leading Airable radio and podcast catalogues. The Airable catalogue contains more than 70.000 radio stations and 70.000 podcasts worldwide. Access Airable in the Hegel Control app.



Roon Ready

Roon is a music management and listening solution which is dedicated to high sound quality and exceptional user experience.

You can stream audio from Roon to the Hegel device. Go to hegel.com/roon to learn more.



UPnP/DLNA

UPnP is a widely used media streaming protocol that is supported by a host of media player products and applications. When using UPnP/DLNA you can stream from locally stored files or music streaming services to the Hegel device. For details on how to set up your media player, please refer to the user manual supplied with the player.

Hegel Control App

The Hegel Control app is used for first-time setup of some of the device's streaming features. It can control streamed music, volume, and inputs. The app also gives you access to Airable internet radio and podcasts, as well as network configuration.

NOTE: Hegel may release automatic feature updates for both the product and the app.

For an up-to-date and in-depth description of its streaming features, please visit support.hegel.com



Device Menu

Navigation

To enter the device menu, turn on the Hegel device and press and hold the COMPUTER PLAY button for 5 seconds. To navigate the menu, use the PREV and NEXT buttons.

To select a sub-menu or feature, press the PLAY button. To exit the menu, navigate to "Exit" and press PLAY. You can also use the source selector to enter and navigate the device menu. See [General Use](#).

NOTE: Some menu features require a connection to the internet to work properly. See [Network Setup](#).

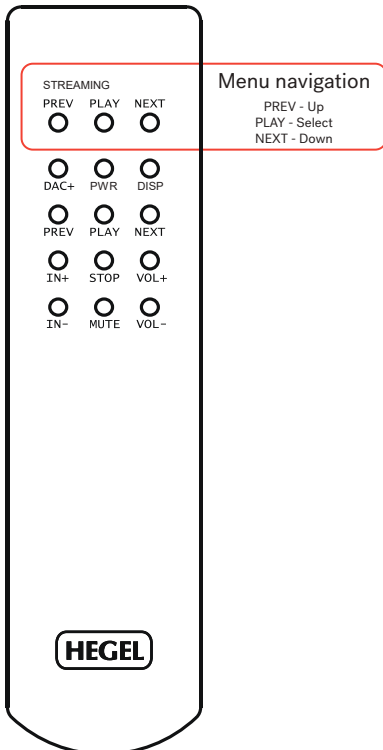

Info

Information about the Hardware Version of your product and the Firmware Version currently running.

Network

Information about the Network Device Name and the IP Address of your device.

Sleep

By default, this Hegel device will automatically go into standby mode after 15 minutes without music, or with a very low signal on the speaker outputs. The Sleep timer can be adjusted or disabled in this menu.

Auto In

Change how the device operates when receiving a signal on digital inputs except USB. Configure Wake on Lan, Auto input switching, and Wake from standby on digital signal.

Volume

Adjust maximum volume and maximum startup volume.

In this submenu, you can also activate the USB Volume feature. This enables you to control the volume of the device with a connected USB source like a computer or a streamer.

Warning: Always remember to check the connected device volume setting before pressing play. With USB volume activated, the amplifier will change its volume to the volume setting on the connected device.

Remotes

Enables you to use your TV remote to turn on your Hegel device and adjust its volume. You can also configure automatic input selection and automatic power on.

*Works with most newer Samsung, Sony, LG, and Philips IR and Smart TV remotes.

HT

Most inputs can be configured to act as a Home Theater input. This will set the input volume at a fixed high volume level. Only connect sources with volume control.

DAC-loop/Digital out

Your device comes equipped with a DAC-Loop function. The function makes it possible to upgrade the digital inputs of the amplifier with an external high-end DAC. This is done by connecting the jitter-reduced coaxial (BNC) digital output of the amplifier to the external DAC. The output of the external DAC must be connected to the XLR input of the amplifier.

In the DAC-Loop submenu, the Network and USB inputs can be enabled separately. Both these inputs take full advantage of the internal synchronous master clock. For these inputs, we recommend leaving the DAC-Loop function disabled as it in most cases will not benefit the sound.

In this submenu, you can also enable the digital output to always be active.

Reset

Here you can reset the product to the default factory settings. This will not affect any firmware updates you have installed.

Exit

Exit the menu

NOTE: The Hegel device menu can be updated with new features and options.

For an up-to-date and in-depth description of the menu and its features, please visit support.hegel.com



Remote Control - RC8

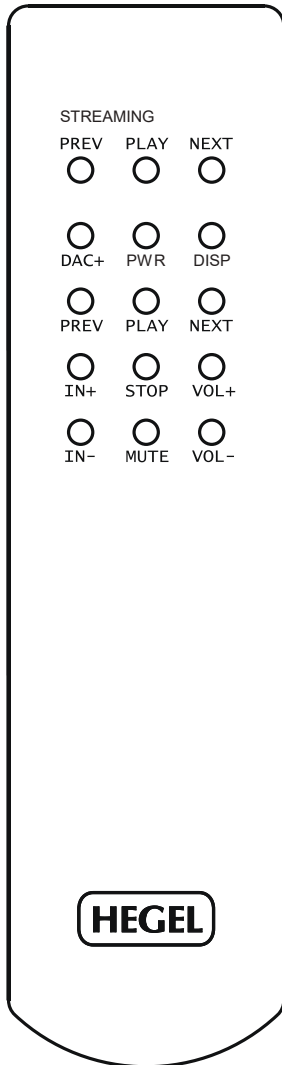

Remote control buttons

PREV	Skip backward on compatible USB or network media players
PLAY	Play/Pause on compatible USB or network media players
NEXT	Skip forward on compatible USB or network media players
DAC+	Input selector on DACs
PWR	Standby on amplifiers
DISP	Display on/off on amplifiers Hold for display off
PREV	Skip backward on CD-players Hold to rewind
PLAY	Play/Pause on CD-players
NEXT	Skip forward on CD-players Hold to fast-forward
IN+	Switch to next input
STOP	Stop on CD-players
VOL+	Volume up
IN-	Switch to previous input
MUTE	Mute on amplifiers
VOL-	Volume down

General information

This Hegel device can be controlled with the included Hegel RC8 Remote Control. The RC8 also controls other Hegel products, such as CD players and preamplifiers, and most connected media players.

Batteries

The remote control uses two standard 1.5-volt LR03 AAA batteries.

To insert the batteries, use a crosshead (Phillips) screwdriver to remove the back lid. When reassembling, be careful not to over-tighten the screws.

General Information

Connecting a subwoofer

The most common way to connect a subwoofer is from the variable line output on your Hegel amplifier. If your subwoofer is equipped with “high-level” speaker wire terminals, you can also use this. Many subwoofer manufacturers recommend this type of connection if it is available.

Please consult your subwoofer manual for detailed instructions on how to connect and configure your subwoofer for the best audio result.

Power

All electrical components should be turned off or set in standby mode when not in use. This is due to safety, because all electrical components can fail, and it is good for the environment. Leaving your product on all the time could also shorten the life expectancy of the product.

That being said, our products sound even better when they are warmed up, typically after about 15 minutes of listening at a moderate volume.

Connecting your TV

The best way to connect your TV is by using one of the optical inputs. If there is no sound, try changing the sound output in the TV’s settings menu. The setting should be changed to “optical” or “digital out” and the signal should be “PCM” or “stereo”. Please consult your TV manual for detailed instructions. If you experience dropouts in sound, please use the Optical 3 input.

The volume on this device can also be controlled by certain TV remotes. See [Device Menu](#) for more information.

Technical Specifications

H400 Streaming Amplifier

Power output	2*250W in 8 ohms Dual Mono
Minimum load	2 ohms
Analog inputs	1*Balanced (XLR) 2*Unbalanced (RCA)
Digital outputs	1*Coaxial (BNC) S/PDIF 24/192
Digital inputs	1*Coaxial (BNC) S/PDIF 24/192, DSD64(DoP), MQA 8x 1*Coaxial (RCA) S/PDIF 24/192, DSD64(DoP), MQA 8x 3*Optical S/PDIF 24/96, MQA 8x 1*USB 32/384, DSD256(DoP), MQA 8x 1*Network 24/192, DSD64, MQA 8x
Line level outputs	1*Unbalanced fixed (RCA) 1*Unbalanced variable (RCA)
Streaming	AirPlay, Roon Ready, Spotify Connect, Google Cast, Tidal Connect, airable radio and podcast, UPnP
Streaming formats	MP3, WAV, FLAC, ALAC, AIFF, DSF, DFF, AAC, PCM, MQA, Ogg
Frequency response	5Hz-180kHz
Signal-to-noise ratio	More than 100dB
Crosstalk	Less than -100dB
Distortion	Less than 0.005% @ 50W 8 Ohms 1kHz
Intermodulation	Less than 0.01% (19kHz + 20kHz)
Damping factor	More than 4000 (main output stage)
Power use in standby (w / wo wake on LAN)	<2W / <0.5W
Dimensions/weight	15 x 43 x 44 cm (HxWxD), 20kg
Dimensions/weight US	5.9 x 16.9 x 17.3” (HxWxD), 44.1 lbs

Safety Instructions

Unpacking and Packing

Remove the top shock absorber. When lifting the amplifier, avoid holding the knobs or connectors. Slide the bag off/on the device. When packing, make sure the bottom shock absorber is placed at the bottom of the original cardboard box. Place the amplifier into the shock absorber. Place the top shock absorber on top of the amplifier.

Placement and Cooling

The Hegel amplifier should be placed on a flat, hard surface for proper cooling. The amplifier must never be placed on a carpet or similar surface as this obstructs air circulation through the unit. To maintain proper ventilation, leave a space of a minimum of 10 cm from the rear, top, and side panels of the device. The front side of the enclosure should be left open.

If overheated, the amplifier will automatically switch itself off. When it cools down the amplifier will turn back on, and the volume will be set to 0.

Warning: The surfaces of the amplifier may become hot during use. If hot, do not touch the panels of the amplifier, and let the amplifier cool down before moving or lifting it.

Connecting the wires

Incorrect connections or damaged wires can cause short circuits, which can damage the amplifier, cause electrical shock, and pose a fire hazard. Follow this manual's installation instructions and ensure all wires are connected correctly before connecting the power source.

Power source

Only use the power source specified on the back panel and ensure the voltage matches the voltage in your area.

High volume

Do not listen to music at high volumes for extended periods of time as this can cause permanent hearing damage and the inability to enjoy this amplifier to its fullest.

Cleaning

Unplug the amplifier from the AC outlet before cleaning. Fingerprints or stains can be removed with a cloth lightly dampened with warm water or a mild detergent suitable for cleaning mirrors and windows.

Proper use

Use the amplifier only for its intended purpose and do not modify or misuse it in any way. The product is designed for indoor use only and must not be exposed to rain or moisture.

Repair

Hegel products should only be opened or serviced by certified technicians. The devices contain electronic components that may cause severe electric shock. Work performed on Hegel products by unqualified personnel may cause serious damage or personal injury.

Opening the product by non-authorized personnel will void the warranty.

Warranty and Disclaimers

Warranty

All Hegel products come with a 2-year warranty against defective materials and workmanship. The warranty is limited to the region where it was originally purchased. There is no need to register the warranty. The purchase receipt will work as a start date for the warranty.

In case you need assistance with your Hegel product, please contact your nearest dealer or distributor. These are listed on our [web-site](#). Our dealers are carefully chosen for their expertise and should be able to help you with any Hegel-related issue.

You can of course always reach us directly by sending an email to info@hegel.com or by contacting us on our social media pages.

For more information about the H400, please visit www.hegel.com



Disclaimers

The Spotify Software is subject to third party licenses found here:

www.spotify.com/connect/third-party-licenses

Use of the Works with Apple badge means that an accessory has been designed to work specifically with the technology identified in the badge and has been certified by the developer to meet Apple performance standards.

Apple, App Store, and AirPlay are trademarks of Apple Inc., registered in the U.S. and other countries and regions.

Google Play and Google Cast are trademarks of Google LLC.

Being Roon Ready means that Hegel uses Roon streaming technology, for an incredible user interface, simple setup, rock-solid daily reliability, and the highest levels of audio performance, without compromise.

MQA and the Sound Wave Device are registered trademarks of MQA Limited. © 2016

The TV remote functionality is not guaranteed to work with all TV remotes from the supported brands.

Technical specifications, streaming options, and features may change without notice.

